

BIO-WALL MAX 18-G AIR PURIFIER

Project Name:	
Architect:	
Engineer:	
Purchaser:	
Submitted By:	

Quantity		Unit(s) Designation	BIO-WALL MAX	Model No.:	BIOM-18-G
----------	--	---------------------	---------------------	------------	------------------

TYPE: OUTWARDLY PROJECTING UV AIR PURIFIER

Standard Features:

Dimensions:	
Lamp Reflector Assembly: Diameter X Overall Length (in)	5.25 X 24 (133 mm x 610 mm)
Ballast Box: Height X Depth X Length (in)	19.4 X 3.2 X 15.4 (493mm x 81mm x 391mm)
Shipping Weight (lbs) Lamp Assembly & Ballast Box	41 lbs (18.6 kg)
Power	120 to 277v AC
Watts	260 w
Display screen	Optional remote 7 in (180 mm) touchscreen
Dry contact - normally close	Link to BMS- lamp in group or individually
Power relay+ switch relay	ON/OFF remotely + contact for door cut off switch
Starting	Hardwire to air handler
Line Cord	No
UV Lamp Type	Proprietary high intensity 19mm mercury vapor quartz
UV Wavelength Nanometers (nm) *	UVC 254nm
UV Lamp Configuration	Straight T6 (5)
UV Lamp length	18 in (457 mm)
Internal Lumina Lamp coating to prevent solarization	Yes
Reflector	Anodized aluminum parabolic reflectors (5)
Lamp Change Out Time	17,000 Hours
Lamp Warranty	2 years
Purifier Warranty	Ballast: 15 years, Electronic : 1 year
Construction	Aluminum /steel/ SS parts
Certifications	cETL _{US} listed
Lamp- part number	LMPHGS180 (5)
Ballast part number	BST120/277SHS (5)

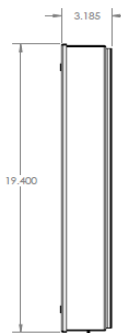
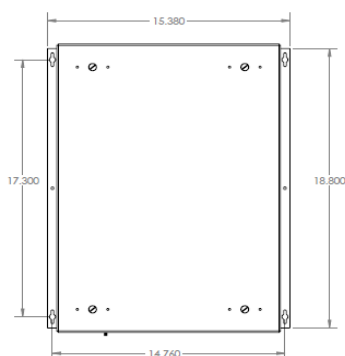
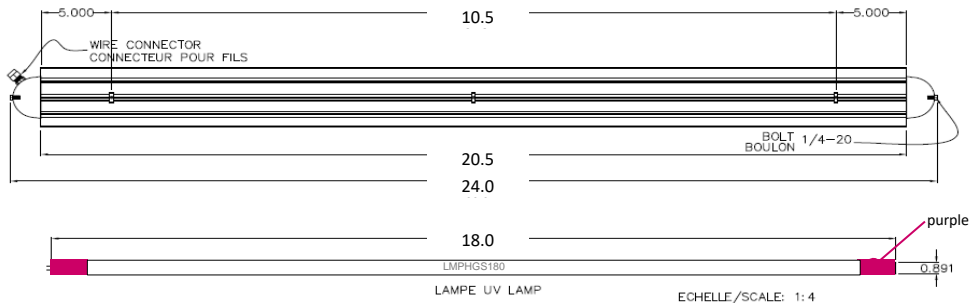

SCALE/ÉCHELLE: 1:3