

SANUVOX

UV Bio-Wall Max series Installation Manual



WARNING

**READ AND FOLLOW ALL INSTRUCTIONS CONTAINED IN THIS MANUAL BEFORE USE.
FAILURE TO COMPLY WITH THESE INSTRUCTIONS MAY RESULT IN PERSONAL
INJURIES OR DAMAGED UNIT.**

All wiring must be done by a professional and in accordance with national and local electrical codes.
Always wear safety glasses and work gloves for protection.

To The Owner

Thank You

Congratulations on the purchase of the Sanuvox UV Bio-Wall Max air purifier. Sanuvox UV air purifiers are the most advanced air purification systems available, having been proven to destroy up to 99.9999% of biological and chemical contaminants that circulate throughout the building or facility. Sanuvox systems have been tested by the EPA (Environmental Protection Agency), The National Homeland Security Research Center, Medical Universities and Independent 3rd Party Laboratories.

Engineered and assembled in Montreal (Quebec), Canada, Sanuvox products are carefully crafted to deliver to you the best that UV air purification can offer and improve your air quality. This new UV Bio-Wall Max air purifier offers many advantages over the previous version such as: single multi-voltage ballast used for all models, BMS control/data and distant monitoring, ballast box air cooling system and availability of a touchscreen to interface with the control circuit.

Table of Contents

About the UV Bio-Wall Max Air Purifier	3	Installation Considerations	7
Important Safety Instructions & Warranty	4	Step by Step Installation	8
Included in the Box	5	Setting & Operating BMS.....	12
Available Options	6	Models & Replacement Parts.....	14

About the UV Bio-Wall Max Air Purifier

GENERAL

The Sanuvox UV Bio-Wall Max is specifically designed to destroy biological and chemical* contaminants such as mold, bacteria, viruses, chemicals*, VOCs* and odors* that may be circulated through the HVAC system of the building or facility.

The Sanuvox UV Bio-Wall Max is installed in the RETURN (preferred) or SUPPLY plenum of the HVAC system treating the air passing through the air duct. The actual percentage of destruction obtained is based on the duct size, percentage of fresh air, velocity, the number of passes and specific contaminants to be treated. Depending on these variables, more than one UV Bio-Wall Max air purifier may be required.

For information or recommendations relative to sizing for your specific application, please call Sanuvox at 1-888-SANUVOX.

*For GX models only

SAFETY CONSIDERATIONS

Installation and servicing of air-conditioning and related equipment can be hazardous due to system pressure and electrical components. Only trained and accredited service personnel should install, repair or service such equipment.

Untrained personnel can perform basic maintenance functions such as replacing lamps. All other operations should be performed by trained service personnel. When working on the UV Bio-Wall Max air purifier, observe precautions in the literature, tags, labels attached to the unit and any other safety precautions considered as best practices in the HVAC industry.

HANDLING CONSIDERATIONS

The UV Bio-Wall Max and its ballast box can be heavy. Make sure proper lifting techniques are used when manipulating those to avoid injuries.

CLEANING CONSIDERATIONS

For optimal air purification performance, the lamps and lamp reflector assembly should be kept free of dust / residue deposit and cleaned regularly using mild soap or alcohol. Always spot test the cleaner to make sure it does not damage the surface.

For the ballast box, occasionally air blow the interior to keep it clean of dust / residue deposit.

Under no circumstances should water be sprayed or splashed onto the UV Bio-Wall Max air purifier.

MAINTENANCE

Replace all UV lamps every 17000 hours (2 years). Refer to part number etched on the lamp or to replacement parts table at the end of this manual.

IMPORTANT SAFETY INSTRUCTIONS

WARNING

Before installing or performing maintenance on the unit, TURN OFF and disconnect unit from power source. Electrical shock may cause personal injuries or possibly death.

Never expose eyes or skin to ultraviolet light from any source. The UV purifier MUST be DISCONNECTED from power source before performing maintenance of service. Personal injury may result.

Do not touch lamp glass without gloves. Reduced performance of lamp may result. Clean lamp after handling.

The UV lamp contains a small quantity of mercury. If a lamp breaks, clean and dispose of with care.

Use only specified replacement lamps with your unit. Use of an incorrect lamp can result in damage to the unit and/or lamp and will also void the warranty.

When applicable local regulations comprises more restrictive installation and/or certification requirements, the aforementioned requirements prevail on those of this document and the installer agrees to conform to these at his own expenses.

When performing installation, servicing or cleaning the UV purifier, it is recommended to wear safety glasses and gloves.

NOTICE

UV lamp can be disposed / recycled after use as any other fluorescent lamp. Contact and follow your local and federal authorities' specific instructions.









WARRANTY

The warranties applicable to the different components included in your purchase are as per the table below:

Component	Warranty
UV lamps provided in the UV Bio-Wall Max	2 years or 17,000 hours *whichever comes first
Ballasts in the UV Bio-Wall Max ballast box	15 years
All other parts of the UV Bio-Wall Max air purifier	1 year
Bio Smart Screen (optional)	1 year

INCLUDED IN THE BOX

The UV Bio-Wall Max air purifier you purchased comprises the following:

Component	Qty
UV Bio-Wall Max lamp reflector assembly and 10ft cable 	1
UV Bio-Wall Max ballast box 	1
Mounting clips 	2
Support flanges 	4
Support rods 	2
Installation Kit - UV Caution Decal - Maintenance Decal - Pair of cotton gloves - Metal tie-wrap (Qty:2) - Snap bushing    	1

AVAILABLE OPTIONS (SOLD SEPERATELY)

The UV Bio-Wall Max air purifier options listed below can be purchased separately and will improve the operation / efficiency of your installation:

Component	Qty
Bio Smart Screen Includes: - Touchscreen + plastic enclosure - 20ft Ethernet cable - Grommet for cable fit	1
Safety cut-off switch (MSCSWC14)	1
Aluminum foil roll 30ft x 6ft (MSCALU30)	1

For more information, please visit our website www.sanuvox.com or contact Sanuvox at 1-888-SANUVOX.

INSTALLATION CONSIDERATIONS

Ensure that the site where the ballast box will be located can be supplied with the necessary power requirements (120-277V @ 50-60Hz). The UV Bio-Wall Max air purifier has a power consumption of up to (775W) each. Power consumption will vary from one UV Bio-Wall Max model to the other (refer to the marking label on your unit).

Make sure that there is adequate clearance for service. Any plastic components in direct line-of-sight of the UV lamps should be shielded from direct UV exposure with aluminum foil or removed when possible.

The suggested temperature range is 4 to 66°C (40 to 150°F). Operating the UV Bio-Wall Max outside this range will result in decreased performance. For optimal performance, air temperature in-duct should be in the range of 15 to 20°C (60 to 70°F).

The UV Bio-Wall Max ballast box is not weatherproof. If installing outdoors, the ballast box must be installed in a watertight enclosure and adequate air circulation must be provided to heat or to cool the ballast box in addition to the one already provided in the ballast box.

Some hardware is not included with the UV Bio-Wall Max air purifier and will need to be provided by the installer in order to complete the installation.

It is mandatory to use a door switch in the final installation. The selected door switch should be approved in the country of installation and suitable for the application. As a minimum, the optional door switch MSCSWC14 should be installed otherwise the selected door switch should at least meet the following requirements (rated insulation voltage: 600V, cycle durability: 500,000).

WARNING

Follow all the Safety Instructions outlined in this document and respect all local and federal codes applicable.

Range of environmental considerations

1) Indoor or outdoor use	Indoor*
2) Altitude	< 2,000m
3) Temperature	5°C to 65°C
4) Relative humidity	Non condensing 70%
5) Mains supply voltage fluctuations	10%
6) Overvoltage category	II
7) Wet location	IPX0
8) Pollution degree	2

* If installed outside, ballast box must absolutely be installed in a waterproof enclosure provided with sufficient air circulation to maintain the temperature in the permissible range.

STEP BY STEP INSTALLATION

1. Select Location

First, select the location of the UV Bio-Wall Max. In order to do so, keep in mind that a straight run of duct is required to accommodate the UV Bio-Wall Max length. Refer to the table below, for minimal straight run depending on the UV Bio-Wall Max model you are installing.

Model	Minimal straight duct length
BIOM18	28in
BIOM24	34in
BIOM30	40in
BIOM40	50in
BIOM50	60in
BIOM60	70in

The preferred location of the UV Bio-Wall Max is the RETURN plenum for optimal operation. The UV Bio-Wall Max may also be installed in the SUPPLY plenum as well. The UV Bio-Wall Max is to be centered in the duct parallel to the airflow.

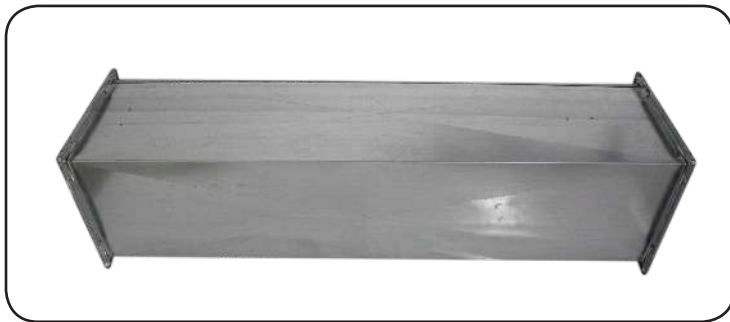

2. Create Access Panel on one side of the duct

After selecting the location for installation, cut an opening on the side of the duct. The dimensions of the opening will depend mostly on two factors: UV Bio-Wall Max model being installed and the dimensions of the duct where it is being installed.

As a generic rule for all UV Bio-Wall Max models, a 3ft per 1ft opening should allow for an easy installation. However, this generic rule might not apply to your particular installation and therefore will require adjustments accordingly.



3. Install Access Door and Safety Cut-Off Switch

Obtain and install an access door that will cover and seal properly the opening you just made in the duct. Install a safety cut-off switch (sold separately) such as when the access door is opened during UV Bio-Wall Max air purifier operation the power will cut off to protect from inadvertent UV exposure.

4. Increase UV Germicidal Efficiency (RECOMMENDED)

This optional step is not required for chemical oxidation applications (UVV Lamp only with blue end cap). If the duct work is not made of aluminum, aluminum sheets or aluminum liner may be affixed in the ductwork surrounding the UV Bio-Wall Max. To determine the length of aluminum lining required, add a 10in to the minimal straight duct length (see Step 1) for your model. When lining the ductwork, keep in mind that the UV Bio-Wall Max should be centered in order to have the aluminum extending equally on each end of the UV Bio-Wall Max. Ideally, use spray adhesive to stick the aluminum foil to the duct. Make sure you use aluminum tape to cover the edges / joints to prevent tear off.

Sanuvox optional P/N MSCALU30 is a 30ft x 6ft roll of heavy aluminum foil with an integrated scrim material for added strength and tear resistance. The foil is laminated to the back of a kraft paper vapor barrier.

5. Cutting the Aluminum Support Rods

The UV Bio-Wall Max is mounted in the center of the duct and held in place by 2 aluminum support rods installed vertically. Measure the height of the duct. Cut the rods 1in shorter than the height of the duct in order to accommodate the flanges on either end.

6. Attach the Mounting Clips to the Support Rods

Two mounting clips which mount to the center of the support rods are included. These mounting clips hold the UV Bio-Wall Max to the support rods. Slide the clips onto the support rods with the open end facing upwards and tighten.

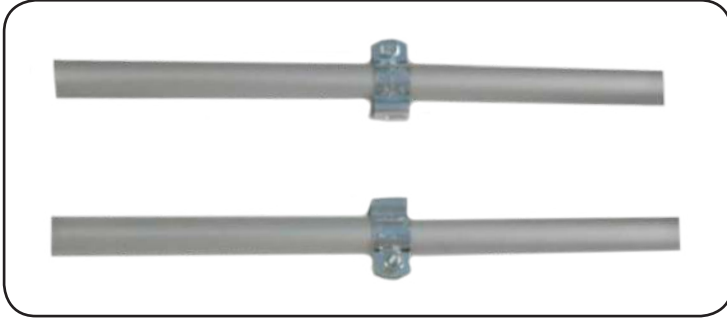

7. Mounting the UV Bio-Wall Max in the Duct

7.1 Attach the 4 flanges to each end of the support rods.



7.2 After determining the ideal location (centered) within the duct, secure the first support rod by attaching the flanges to the duct walls with sheet metal screws. Mounting clip should be facing inward and the notch upward.



7.3 Validate the orientation of the UV Bio-Wall Max to the air-flow which should be parallel for optimal performance.

7.4 Measure the distance from one threaded extremity to the other (between the nuts where the mounting clips will sit) of the UV Bio-Wall Max lamp reflector assembly. Considering the mounting clips are installed on the support rods, in conjunction with the measurement just made, determine where the second support rod should be positioned in order for the threaded tips to sit comfortably on the mounting clips.

7.5 Secure the second support rod by attaching the flanges to the duct wall with sheet metal screws. Mounting clip should be facing inward and the notch upward.



7.6 Secure the UV Bio-Wall Max on the clips by tightening the adjustment nuts located at each extremity of the lamp reflector.



8. Mount the UV Bio-Wall Ballast Max Box

Install the ballast box in a convenient and easily accessible location. This location could either be on the duct or on the wall. Make sure the required power is nearby available and that the cable (10ft) connected to the UV Bio-Wall Max will reach the ballast box.



9. Connecting the UV Bio-Wall Max to the Ballast Box

9.1 Drill a hole (diameter of 1 1/8in) in the duct in order to pull the UV Bio-Wall Max cable out of the duct. To select the location of this hole, consider the bending radius of the cable. Try keeping the hole in the vicinity of the closest support rod in order to minimize the length of the cable left in the duct and also to easily be able to attach the cable to the support rod with the 2 metal tie-wraps provided. Fit in the snap bushing provided in the drilled hole you just made.

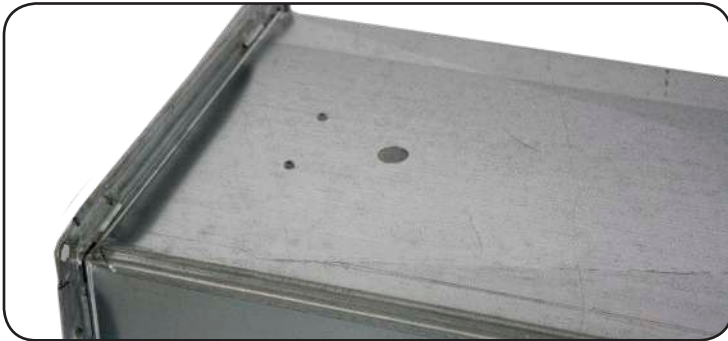

9.2 Take the cable and pull it through the bushing out of the duct. Use the 2 included metal tie-wraps to tie down the cable to the support rod. We recommend applying a seal around the cable at the intersection with the bushing to reduce pressure loss in the duct.

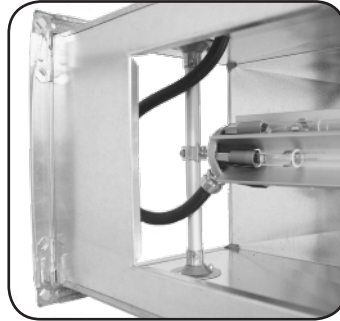

9.3 Connect the cable of the UV Bio-Wall Max to the ballast box. Pull the colored wire-set (20 wires) from the UV Bio-Wall Max into the ballast box through the knockout located between the 2 fans and secure the cable connector to the ballast box.

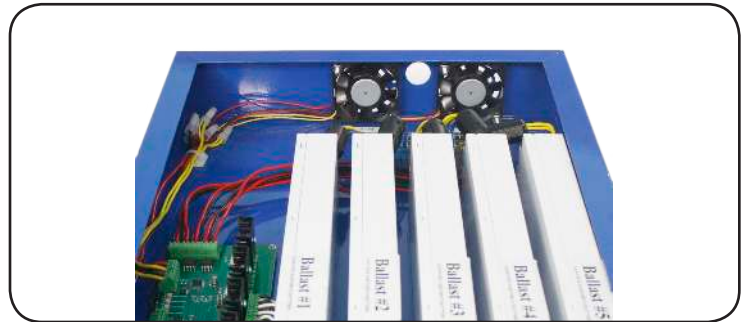

Each set of 4 wires (2 blue and 2 yellow) are labelled 1 to 5 and correspond to lamp 1 to lamp 5. Ballasts 1 to 5 are labelled accordingly and lamps 1 to 5 are identified on the terminal block where the associated wires should connect.



Refer to wiring diagram at the back of the cover of the ballast box. Using a small screw driver, press in the latch and insert the appropriate wire in the terminal block connector then release the screw driver. The wires should hold firmly into the terminal block connector.

10. Connecting the Door Switch and BMS to the Ballast Box

10.1 Follow the wiring instructions provided with the door switch and connect wires accordingly to the PCB in the SW and 5V connectors. Refer to the wiring diagram located at the back of the cover of the ballast box for PCB connection.

10.2 BMS connection is optional and not required for the UV Bio-Wall Max air purifier to operate.

However, if desired, there are 3 Modes available for BMS connections. In order to use the BMS, the user needs to provide 24VDC and 0V to the PCB.

Refer to next section for more details.



WARNING

Connecting the power to the ballast box should only be performed by an accredited electrician in your jurisdiction.

11. Connect Power to the Ballast Box

Use one knockout from the three provided to bring in the power to the ballast box. Connect black to black « Line In » and white (common) to common in the quick disconnect. Finally, attach ground (green) to the grounding stud clearly identified in the ballast box. Close the ballast box using the cover and apply the caution stickers provided in the installation kit on the duct access door to the UV Bio-Wall Max.

You are now ready to power ON your new UV Bio-Wall Max air purifier!

Wiring diagram

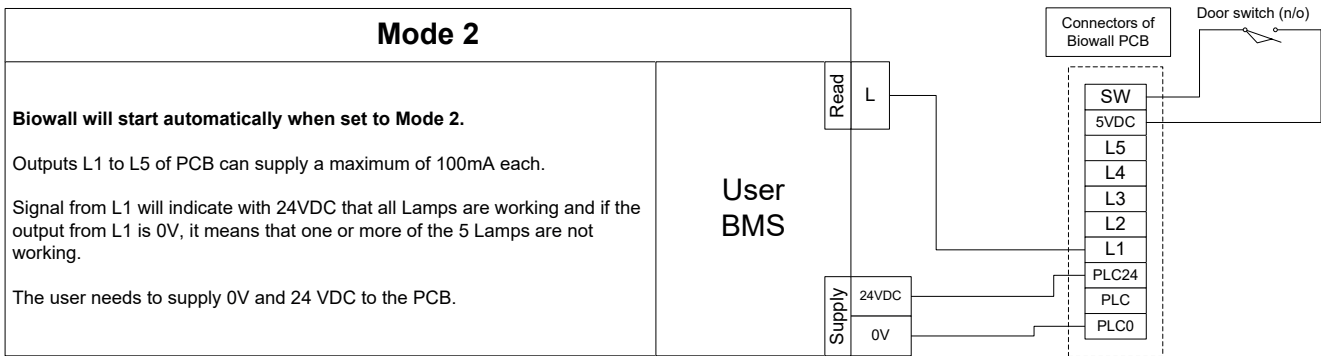
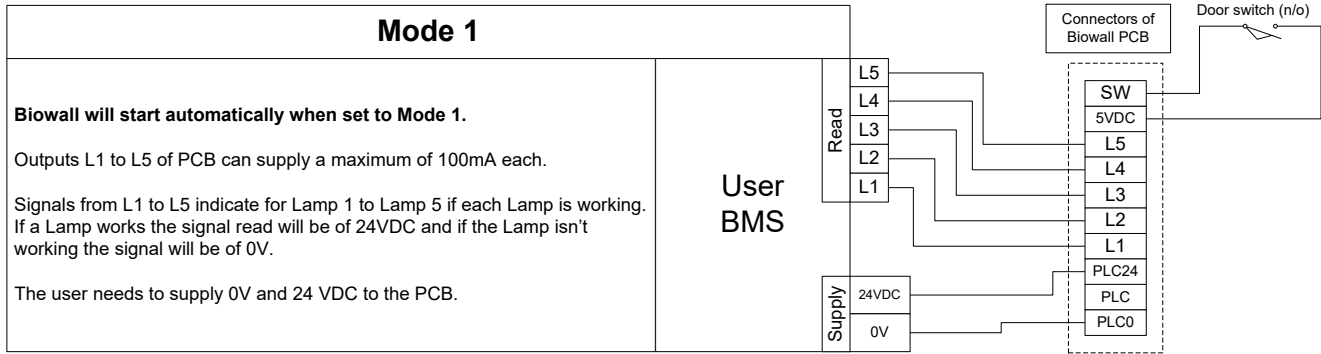
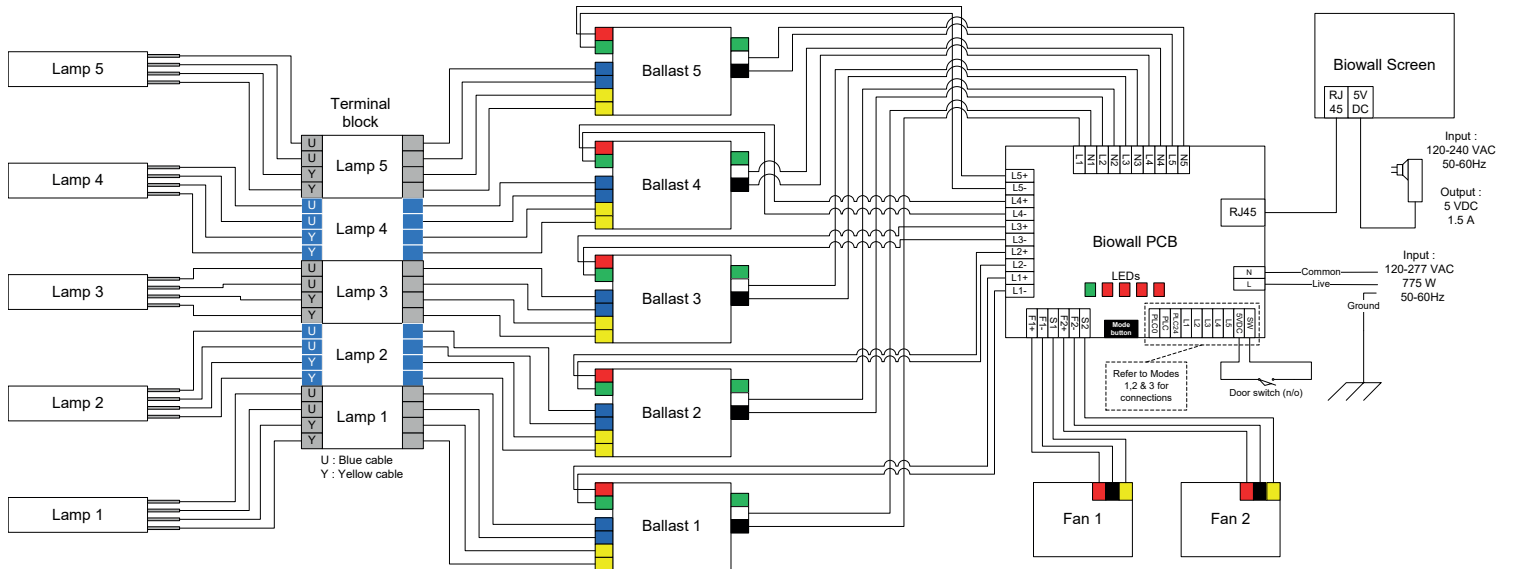

Mode 3

Outputs L1 to L5 of PCB can supply a maximum of 100mA each.
The user needs to supply 0V and 24 VDC to the PCB.
If jumper is in position BP, Biowall will start automatically.
Otherwise, the Biowall will start only if activated through the PLC signal provided to the PCB from the user BMS. PLC signal of 24VDC will turn on the Biowall and a signal of 0V will turn it off.

The signals from the PCB in Mode 3 are the following:
L1 corresponds to Door Closed (24VDC) or Door Open (0V)
L2 corresponds all Lamps working (24VDC) or one or more lamp is not working (0V)
L3 corresponds to Fan 1 working (24VDC) or not working (0V)
L4 corresponds to Fan 2 working (24VDC) or not working (0V)
L5 corresponds to all lamps have less than 2 years (24VDC) or one or more lamp is over 2 years (0V)

User
BMS

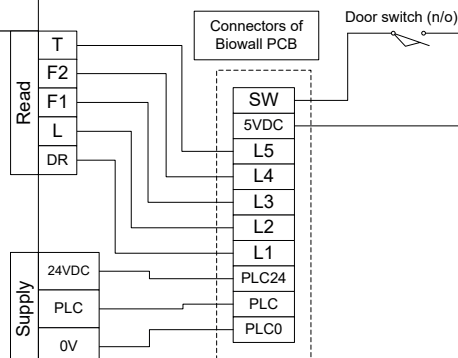

Instructions to set Mode 1 to 3

1. Turn OFF the power to the UV Bio-Wall ballast box.
2. Turn ON the power to the UV Bio-Wall ballast box, the 5 LEDs will blink alternatively GREEN and RED during 5 seconds then the Mode which is already set, prior to turning the unit OFF, will show GREEN (all the remaining LEDs will show RED).
3. You have 5 seconds to press the Mode Button to move from one Mode to the next. By holding in the button the Modes will shuffle one to the next.
4. For Mode 1, press the Mode Button until the LED 1 is GREEN (all remaining LEDs will be RED). The same logic applies for Mode 2 and 3.
5. Once you selected the Mode you want, wait 5 seconds for the UV Bio-Wall to initiate the firing sequence of the lamps.

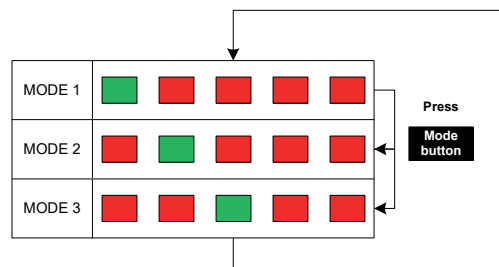

Instructions to reset Lamp Timer

1. Press and Hold the Mode button until the LEDs flash RED and then turn GREEN.
2. The countdown timer for all Lamps is reset to 2 years.

SANUVOX
LBLBWDWG-1

Connections requirements

- Dedicated breaker with a 10A minimum rating
- Door switch has to work on 5VDC

SETTING and OPERATING THE BMS (OPTIONAL)

The BMS default mode, as it leaves the factory, is set to Mode 2. If you want to set a different mode follow the instructions outlined in this section.

MODE	Description
1	<p>Signals from L1 to L5 indicate for Lamp 1 to Lamp 5 if each lamp is working. If a Lamp works the signal read will be of 24VDC and if the Lamp isn't working the signal will be of 0V.</p> <p>This Mode allows the user to monitor each Lamp individually and receive a signal when there is a problem with a Lamp requiring service to the UV Bio-Wall Max</p>
2	<p>Signal from L1 will indicate with 24VDC that all Lamps are working and if the output from L1 is 0V, it means that one or more of the 5 Lamps are not working.</p> <p>This Mode allows the user to monitor the Lamps globally through one signal. The user will know that there is a problem with one or more Lamp requiring service to the UV Bio-Wall Max but won't know specifically which Lamps are problematic.</p>
3	<p>This Mode provides diverse informations such as :</p> <p>L1 corresponds to Door Closed (24VDC) or Door Open (0V)</p> <p>L2 corresponds to all Lamps working (24VDC) or one or more lamps is not working (0V)</p> <p>L3 corresponds to Fan 1 working (24VDC) or not working (0V)</p> <p>L4 corresponds to Fan 2 working (24VDC) or not working (0V)</p> <p>L5 corresponds to all lamps have less than 2 years (24VDC) or one or more lamp is over 2 years (0V)</p> <p>*With this Mode, the user also has the possibility to remotely turn ON and OFF the unit by bringing signal to the PLC connector by moving the jumper per picture 1 attached.</p>



* Picture 1

1. Set a BMS Mode

1.1 Turn OFF the power to the UV Bio-Wall Max ballast box and remove cover.

1.2 Turn ON the power to the UV Bio-Wall Max, the 5 LEDs will blink alternatively GREEN and RED during 5 seconds then the Mode which is already set, prior to turning the unit OFF, will show GREEN (all remaining LEDs will show RED).

1.3 From the moment you turn ON the power, you have 5 seconds to press the Mode Button on the PCB to move from one mode to the next. By holding the button the modes will shuffle one the next until pressure is released.

1.4 For Mode 1, press the Mode Button until LED 1 is GREEN (all remaining LEDs will be RED). The same logic applies to select Mode 2 and 3.

1.5 Once you select the mode you want, wait 5 seconds for the UV Bio-Wall Max to initiate the firing sequence of the lamps.

2. Reset the Lamp Timer

2.1 Press and hold the Mode Button until the LEDs flash RED and then turn GREEN. This indicates that the 2 years countdown timer for all lamps has been reset to zero.

Information provided by the LEDs

When you are not using a BMS or the optional Bio Smart Screen, the only way to know if there is a problem with your UV Bio-Wall Max air purifier is to open the cover of the ballast box and check the LEDs on the PCB (Control Circuit). When removing the cover, proceed with caution since the PCB has component that operate a high voltage.

The different cases possible are the following:

If the 2 fans are OUT, the PCB will prevent the ballast from firing up the lamps. At least one fan needs to be working for the PCB to fire up the lamps.

If the 2 fans are OUT, the LEDs will all be RED.

LED green: lamp and ballast are ON and the lamp has less than 2 years of operation

LED red: problem with lamp and/or ballast, if all LEDs are red and indicates that the door switch is open or that in Mode 3 the PLC signal is ON

A less probable scenario would be that all lamps and/or ballasts have problems.

Flashing LED (red and green): indicates that the lamp is ON but have been operating for more than 2 years

Models available

Model	Description
BIOM18G or BIOM18GX*	In-duct UV air purifier consists of 5 x 18in high intensity UVC lamps
BIOM24G or BIOM24GX*	In-duct UV air purifier consists of 5 x 24in high intensity UVC lamps
BIOM30G or BIOM30GX*	In-duct UV air purifier consists of 5 x 30in high intensity UVC lamps
BIOM40G or BIOM40GX*	In-duct UV air purifier consists of 5 x 40in high intensity UVC lamps
BIOM50G or BIOM50GX*	In-duct UV air purifier consists of 5 x 50in high intensity UVC lamps
BIOM60G or BIOM60GX*	In-duct UV air purifier consists of 5 x 60in high intensity UVC lamps

* The suffix GX indicates that the unit has 4 germicidal lamps and 1 oxidizing and germicidal lamp. Refer to replacement parts below for more details.

Replacement parts

Part Number	Description
BST120/277SHS	Ballast with mutli-voltage input of 120 to 277V (50-60Hz)
LMPHGS180	T6 High Intensity Germicidal (UVC) 18in straight UV lamp for BIOM18G
LMPHGS240	T6 High Intensity Germicidal (UVC) 24in straight UV lamp for BIOM24G
LMPHGS300	T6 High Intensity Germicidal (UVC) 30in straight UV lamp for BIOM30G
LMPHGS400	T6 High Intensity Germicidal (UVC) 40in straight UV lamp for BIOM40G
LMPHGS500	T6 High Intensity Germicidal (UVC) 50in straight UV lamp for BIOM50G
LMPHGS600	T6 High Intensity Germicidal (UVC) 60in straight UV lamp for BIOM60G
LMPHGXS180	T6 High Intensity Dual Zone (UVC / UVV) 18in straight UV lamp for BIOM18GX (1 out 5) other 4 are LMPHGS180
LMPHGXS240	T6 High Intensity Dual Zone (UVC / UVV) 24in straight UV lamp for BIOM24GX (1 out 5) other 4 are LMPHGS240
LMPHGXS300	T6 High Intensity Dual Zone (UVC / UVV) 30in straight UV lamp for BIOM30GX (1 out 5) other 4 are LMPHGS300
LMPHGXS400	T6 High Intensity Dual Zone (UVC / UVV) 40in straight UV lamp for BIOM40GX (1 out 5) other 4 are LMPHGS400
LMPHGXS500	T6 High Intensity Dual Zone (UVC / UVV) 50in straight UV lamp for BIOM50GX (1 out 5) other 4 are LMPHGS500
LMPHGXS600	T6 High Intensity Dual Zone (UVC / UVV) 60in straight UV lamp for BIOM60GX (1 out 5) other 4 are LMPHGS600
MSCALU30	Bio-Film aluminum foil for UV Bio-Wall Max installation 30ft x 6ft roll
MSC9	Pair of flanges for all aluminum support rod. Priced per pair.
MSCCON19	Pair of connectors for aluminum mounting support tube part TUBAA66 to flange MSC9. Priced per pair.
TUBAA66	Aluminum mounting tube 66 inches in length
BIOSCREEN	Bio Smart Screen
MSCCON41	Ceramic lamp connector